



OPEL MERIVA

2003 -

Cat. No. **O/035**

EKG/ONZ: nr. 10/09



1360Kg



60Kg

**D = 7,60kN**

D (kN) =



MAX kg x MAX kg

x 0,00981



MAX kg + MAX kg



**IMIOLA HAK-POL**

96-111 KOWIESY, CHOJNATA 23A, POLAND

tel. +48 46 831 73 31, fax +48 831 74 29

e-mail: office@imiola.pl, www.imiola.pl

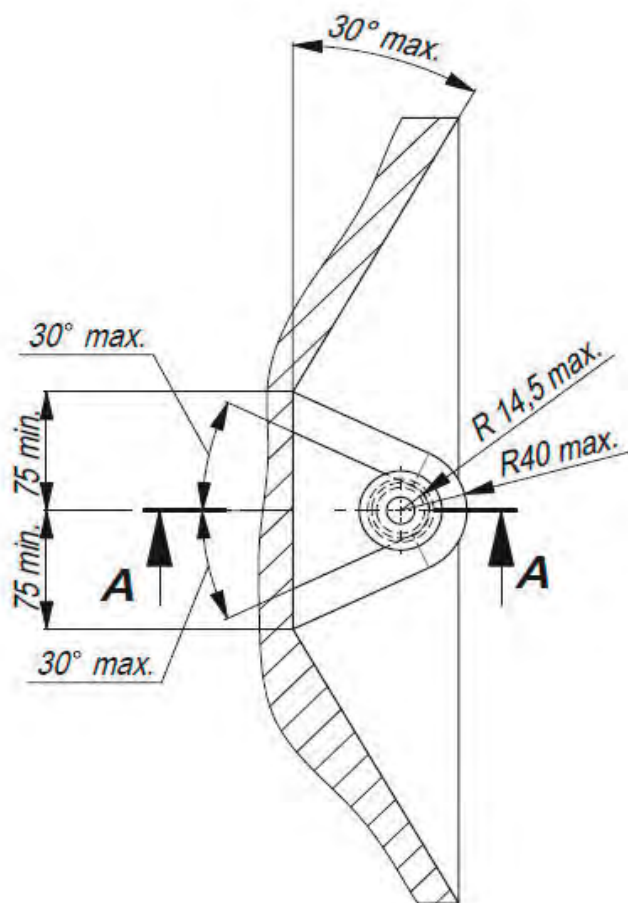

PRZEKRÓJ A-A

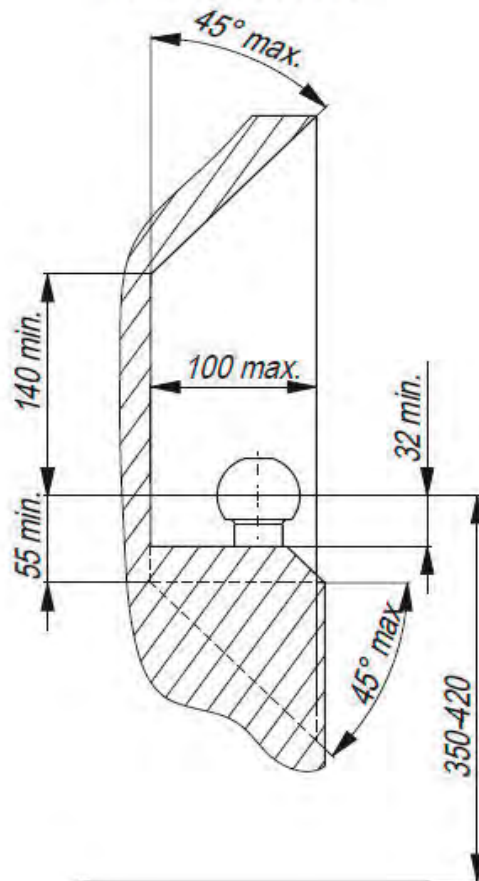

**PL** Należy zagwarantować przestrzeń swobodną według załącznika VII, rysunek 25a/b Regulaminu EKG ONZ 55.01 przy dopuszczalnym ciężarze całkowitym pojazdu.

**GB** The clearance specified in appendix VII, diagram 25a/b of Regulation No. 55.01 UN EU must be guaranteed at laden weight of the vehicle.

**F** L'espace libre doit être garanti conformément à l'annexe VII, illustration de la réglementation 55.01 CE pour un poids total en charge autorisé du véhicule.

**D** Der Freiraum nach Anhang VII, Abbildung 25a/b der Vorschriften 55.01 EG ist zu gewährleisten bei zulässigem Gesamtgewicht des Fahrzeuges

**Moment skrecający dla śrub i nakrętek (8.8)**  
**Torque settings for nuts and bolts (8.8)**

<b>M8</b>	<b>25Nm</b>
<b>M10</b>	<b>55Nm</b>
<b>M12</b>	<b>85Nm</b>
<b>M14</b>	<b>135Nm</b>
<b>M16</b>	<b>195Nm</b>



Śruba M10x40-8.8 ; Bolt  
 Podkł. spręż. 12,2 ; Spring Washer  
 Podkł. okr. Ø30xØ10,5x 3 ; Plain Washer

Nakrętka M10 ; Nut  
 Podkł. spręż. 10,2 ; Spring Washer  
 Podkł. okr. Ø30xØ10,5x 3 ; Plain Washer











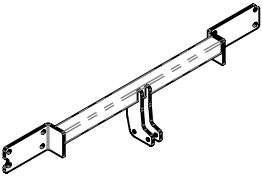
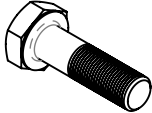
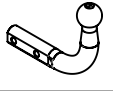

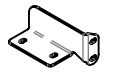

Nakrętka M12 ; Nut  
 Podkł. spręż. 12,2 ; Spring Washer  
 Podkł. okr. 13 ; Plain Washer

Śruba M10x130-8.8 ; Bolt

Nakrętka M10 ; Nut  
 Podkł. spręż. 10,2 ; Spring Washer  
 Podkł. okr. 10,5 ; Plain Washer

Śruba M12x70-8.8 ; Bolt

Nakrętka M10 ; Nut  
 Podkł. spręż. 10,2 ; Spring Washer  
 Podkł. okr. Ø30xØ10,5x 3 ; Plain Washer

	A	x1		M12x70	2
				M10x130	3
				M10x40	8
	B	x1		M12	2
				M10	11
	C	x1		Ø30xØ10,5x3	11
	D	x1			
	E	x1		13	2
				10,5	8
	F	x1		12,2	2
				10,2	11
	G	x1			
	H	x1			
	I	x3			
	J	x1			
	K	x1			

Śruba M10x40-8.8 ; Bolt  
 Podkł. spręż. 12,2 ; Spring Washer  
 Podkł. okr. Ø30x Ø10,5x 3 ; Plain Washer

Śruba M10x130-8.8 ; Bolt

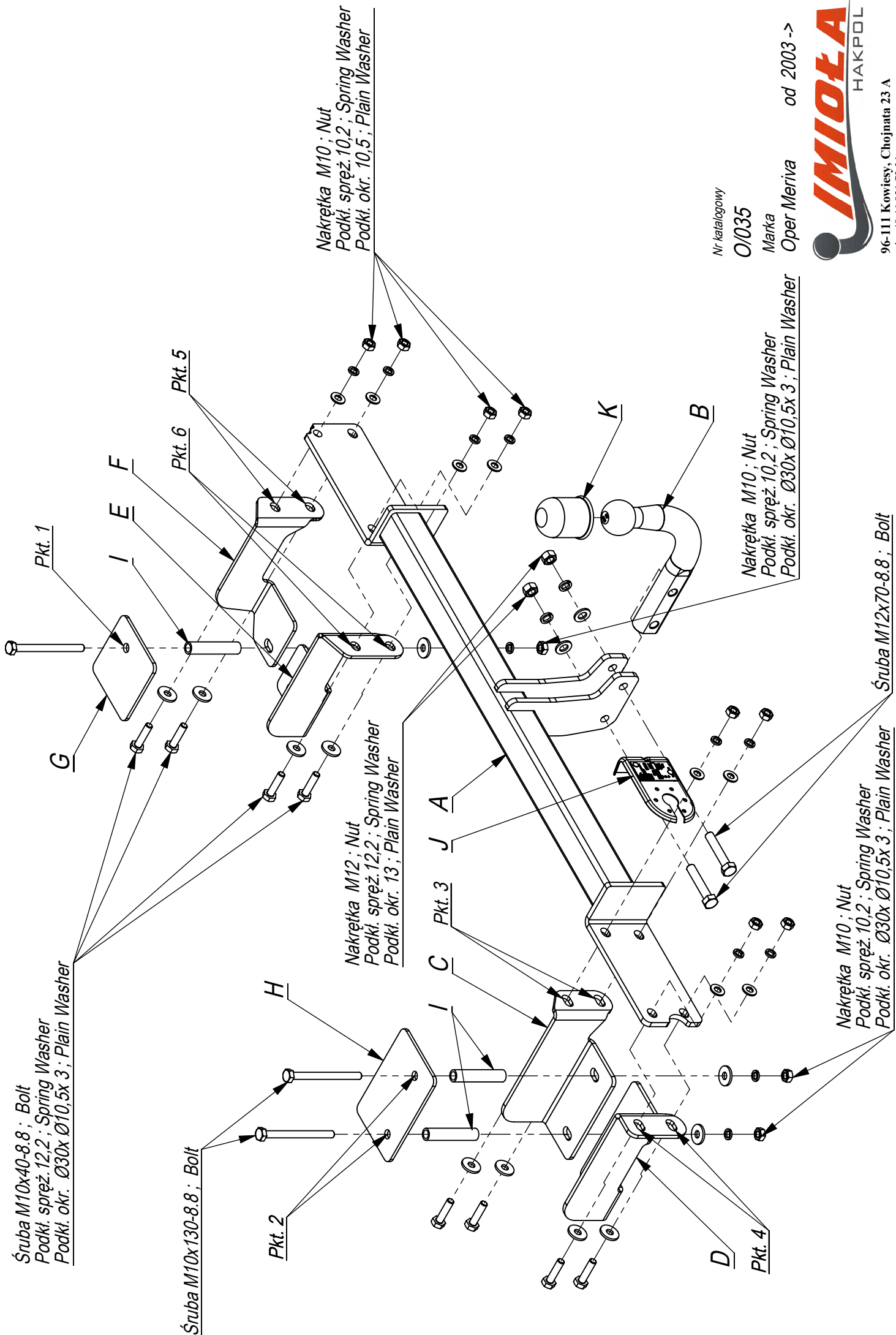

Nakrętka M10 ; Nut  
 Podkł. spręż. 10,2 ; Spring Washer  
 Podkł. okr. 10,5 ; Plain Washer

Nakrętka M12 ; Nut  
 Podkł. spręż. 12,2 ; Spring Washer  
 Podkł. okr. 13 ; Plain Washer

Nakrętka M10 ; Nut  
 Podkł. spręż. 10,2 ; Spring Washer  
 Podkł. okr. Ø30x Ø10,5x 3 ; Plain Washer

Nakrętka M10 ; Nut  
 Podkł. spręż. 10,2 ; Spring Washer  
 Podkł. okr. Ø30x Ø10,5x 3 ; Plain Washer

Śruba M12x70-8.8 ; Bolt

Nr katalogowy

O/035

Marka

Oper Meriva

od 2003 ->



96-111 Kowiesy, Chojnata 23 A  
 tel. +48 46 831 73 31

- Odkręcić zderzak oraz metalowe wypełnienie zderzaka (nie będzie już montowane).
- Z bagażnika wyjąć wykładzinę oraz usunąć boczne ścianki.
- Przyłożyć belkę haka A do tylnego pasa tak, aby otwory w haku pokryły się z technologicznymi otworami w samochodzie, a następnie skręcić z elementami C i D oraz E i F śrubami M10x40 8.8 (pkt 3, 4, 5 i 6).
- Przewiercić w bagażniku, w miejscach fabrycznie zaznaczonych otwory  $\varnothing$  17 mm. Włożyć w nie śruby M10x120 8.8, tuleje dystansowe L=85 oraz nakładki i skręcić z elementami C i D, E i F (pkt 1 i 2).
- Włożyć wykładzinę zderzaka.
- Dokręcić wszystkie śruby z momentem wg tabeli.
- Wyciąć w dolnej części zderzaka fragment 110x50.
- Przykręcić zderzak.
- Przykręcić kulę i blachę gniazda elektrycznego śrubami M12x70 8.8.
- Podłączyć instalację elektryczną.

- Unscrew the bumper and metal filling of the bumper (it will not be used any more).
- Take out the covering from the boot and remove side panels.
- Put the main bar A to the rear belt in this way so the holes in the tow bar agree with the technological holes in the car, next screw with the elements C, D and E, F śrubami M10x40 8.8 (points 3, 4, 5 and 6).
- Drill the holes  $\varnothing$  17 mm in the boot, in the marked points. Put the bolts M10x120 8.8, distance sleeves L=85 and plates in these holes and screw with the elements C, D and E, F (point 1 and 2).
- Put the covering to the boot.
- Tighten all the bolts according to the torque setting- see the table.
- Cut out the fragment 110x50 in the lower part of the bumper.
- Screw the bumper.
- Fix the ball and electric plate with bolts M12x70 8.8.
- Connect the electric wires.

- Dévisser le pare-chocs et le remplissage en métal du pare-chocs (il ne sera plus utilisé).
- Enlever le revêtement du coffre et enlever les parois latérales.
- Mettre la poutre du crochet d'attelage A à la bande postérieure pour que les trous dans le crochet d'attelage soient adjacents aux trous technologiques dans la voiture et ensuite visser avec les éléments C et D et serrer avec les boulons M10x40 8.8 (point 3,4,5 et 6) aux éléments E et F.
- Forer des trous dans le coffre dans des lieux déterminés par le constructeur, au diamètre de  $\varnothing$  17 mm. Insérer les boulons M10x120 8.8, les douilles à vis L=85 et serrer les rondelles avec les éléments C et D, E et F (point 1 et 2).
- Remettre le revêtement dans la coffre.
- Serrer tous les boulons avec un couple de serrage selon tableau.
- Ouvrir la partie basse de pare-chocs de 110x50.
- Przykręcić zderzak.
- Visser la boule et la tôle de la prise électrique avec les boulon M12x70 8.8.
- Raccorder le circuit électrique.

